

Article number: 0106087

Description: Retaining ring JV 80

Measures

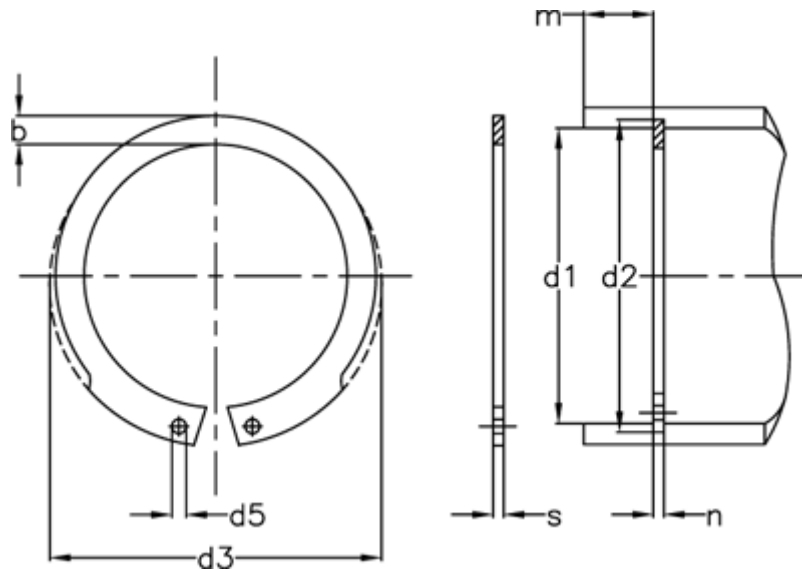

AN mm ²	= 224	FRg kN	= 2.5	tol	= 0.3
b	= 6.0	FR kN	= 110.0	tol	= -0.07
d1	= 80	g	= 2.5	tol	= +0,31-0,54
d2	= 83.5	K kN-mm	= 196.0	tol	= +0,35
d3	= 85.5	m min	= 2.65	Tong	= ZGJ-3
d5 min	= 2.5	Nominal drive	= 5.3	Weight kg/1000	= 22.90
Description	= JV 80	s	= 2.50		
FN kN	= 37.40	t	= 1.75		